

20'

DAWN[®]

Heavy Duty Marker System

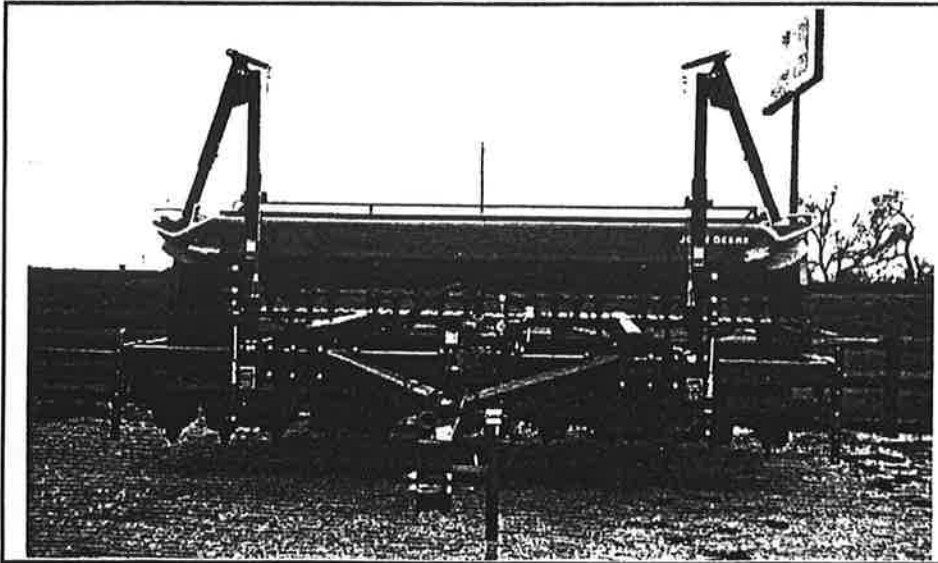

The DAWN Heavy Duty Marker, (1915 and 1920), are designed to fit the John Deere 750 Drill. The DAWN Marker is specially designed to work in all field conditions by leaving a highly visible mark in heavy corn stalks, sod or freshly worked ground. It reduces operator fatigue and increases planting efficiency by eliminating the need to turn around to follow the rows. The DAWN Heavy Duty Marker has a unique low pivot/load bar design and breakaway protection. Transport width is within the drill width and height is lower than tractor cab height on most models. Patent Pending

Introduction



Read this manual completely before beginning assembly, this will help assure proper installation and operations. Failure to read and follow this manual carefully could result in personal injury.

This manual is a permanent part of your DAWN Heavy Duty Marker System and should remain with the system when you sell it.

For instructional purposes, **Right-Hand** and **Left-Hand** sides are determined by operators seat in the tractor. **Forward** direction should always be facing the tractor.

Measurements in this manual are of the English design, (inches). Use English hardware and tools as specified.

Fill out the product warranty card and list lot number , which is located on the saddle mount of each marker arm, on the warranty card to assure the best customer service in the future.

Safety

Recognize symbols and information

This is the safety-alert symbol. When you see this symbol on your machine or in this manual, be alert to the potential for personal injury. — Recommended safety precautions and warnings are listed carefully in this manual.



Know the difference in signal words

Words like Danger, Warning and Caution are used with the safety-alert symbol. Warning labels are near specific hazards.



Always be prepared for emergencies

Keep a first aid kit near by at all times. Keep emergency numbers for doctors, ambulances, hospitals and fire departments near your telephone.

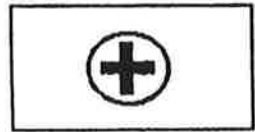

AVOID INJURY FROM FALLING MARKER:

1. SECURE MARKER IN UPRIGHT POSITION WITH MARKER PIN FOR TRANSPORTATION, SERVICE OR STORAGE.
2. BE SURE CYLINDER AND ATTACHING HOSES ARE FULLY CHARGED WITH OIL BEFORE REMOVING MARKER LOCKUP PIN. FAILURE TO DO SO WILL ALLOW MARKER TO FALL RAPIDLY!
3. STAY CLEAR OF MARKERS DURING RAISING AND LOWERING.

Label 100-221 is located on inner arm of marker.



Label 100-219 is located on pinch points.

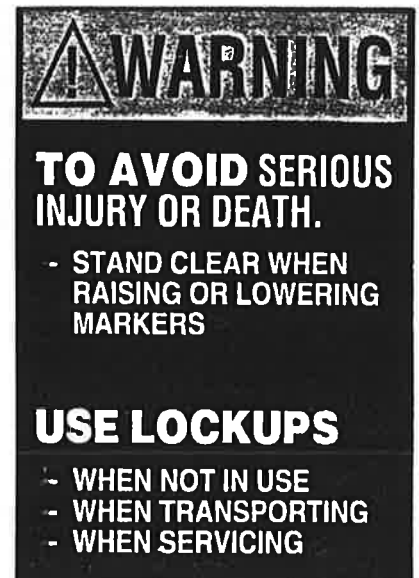

Label 9117 is located on the saddle mount.

TO AVOID SERIOUS INJURY OR DEATH

1. Before operating, make sure the cylinders and the connected hoses are **FULLY CHARGED WITH OIL**. Failure to do this may cause the marker arm to fall rapidly!
2. Operator must be sure the **AREAS ON BOTH SIDES OF THE MACHINE ARE CLEAR** before raising or lowering either marker arm!
3. When storing, servicing or transporting, **USE MARKER LOCKUPS!**
4. **Do Not** stand directly under raised markers and **BE AWARE OF THE NOTCHED DISC AT ALL TIMES!**
5. Assembled parts are moveable, **BE AWARE OF PINCH POINTS!**

Instructions For Assembling, Mounting, Operating and Servicing

DAWN EQUIPMENT COMPANY MODEL 1915 HD MARKER
(for mounting to John Deere Model 750 Drill Only)



WARNING! (Assembly and Mounting)

- Complete below instructions for both sides before attaching to any hydraulic power source!
- All assembly is done with marker arms in the extended (horizontal) position. Marker arms are not to be raised until hydraulic power source is applied!
- Two people are required for assembling and mounting the DAWN Heavy Duty Marker System because of the weight of the arms!
- The installers should wear protective gloves, steel toed boots and hard hats!
- Read these instructions completely before beginning assembly or operation. Follow the steps in the instructions to assure proper assembly and operation!
- Do not attach the hub end assembly and notched disc until instructed to do so!

Step 1 Unpack all parts, lay out on floor or other work surface and check all parts against Component and Hardware parts lists. Note "left-hand", "right-hand", "forward" and "rear" are defined as they appear to an operator sitting in the operators seat facing in the direction of forward travel. "Inner" and "outer" are determined relative to the centerline of the machine. Note for all assembly: Left Hand side is shown, Right Hand is similar except as noted.

Step 2 Inner Arm Assembly (1) is shipped with breakaway preassembled. The following steps are for reference or service only: Assemble one Inner Arm Assembly (1) at the breakaway point. Insert pivot block on (3) between lugs on (2); check there is no weld spatter or foreign matter between mating parts. Pin boss on (3) must be on same side of tube as cylinder mounting plate on (2).

Assemble each Breakaway Pivot using two 5/8 x 5 UNC Grade 8 (5 marks on head) Hex Head Cap Screws (HHCS) (49), four 5/8 SAE Hardened Flatwashers (50), and two 5/8 Grade 8 Locknuts (51). Leave 5/8 screws

ADDITIONAL INFORMATION FOR DAWN 20' HD MARKER SYTEM

DAWN HD MARKER MODEL 1920
(for John Deere 750 20' Drill Only)

MODEL #1920, DAWN 20' HD MARKER HAS A STORAGE AND TRANSPORT HEIGHT OF 10'4". EXTREME CAUTION MUST BE USED TO AVOID ELECTRICAL LINES, TREES AND ANY OTHER OVERHEAD STRUCTURES OR VEGETATION THAT MAY COME IN CONTACT WITH THE MARKER ARMS IN ORDER TO AVOID SERIOUS INJURY & DEATH!

READ OPERATION MANUAL COMPLETELY AND FOLLOW ALL STEPS IN SEQUENCE TO AVOID INCORRECT OPERATION OF THE MARKER AND TO AVOID SERIOUS BODILY INJURY AND DEATH!

IN ADDITION TO THESE WARNINGS FOR THE DAWN 20' MARKER, FOLLOW THE DAWN 15' HD MARKER SYSTEM INSTRUCTIONAL MANUAL IN SEQUENCE FOR PROPER ASSEMBLY, MOUNTING, OPERATING AND SERVICING.

(49) finger tight only until 1/2 x 3.5 breakaway bolts are installed and tightened. See Figure 1.

Install Breakaway bolts: Install two 1/2"-13 x 3-1/2" long UNC SAE grade 5 (3 marks on head) HHCS (46), 1/2" hardened SAE (1.06 OD) flatwashers (47) under the head of the screws, and 1/2-13 UNC Grade 8 flange locknuts (48) in each arm assembly, as shown in figure 1.

IMPORTANT: Torque the 1/2"-13 UNC x 3-1/2" Long SAE Grade 5 Breakaway bolts (46) to 90-100 ft lbs. Proper screws, washers, nuts and bolt torque must be maintained for proper breakaway performance.

After torquing the 1/2" x 3-1/2 breakaway bolts (46), then torque the 5/8" x 5 bolts (49) to 140-150 ft lbs. See additional Breakaway information later in these instructions.

Assemble Hydraulic cylinder slide plate (4) to inner arm using two 3/4" x 2.75 long carriage bolts (52), slide plate (4), Two step bushings (53) and two 3/4 locknuts (54) as shown in fig 1. Slide plate must be on centerline of 4"x3" tube (2)! Round hole on slide plate (4) is away from breakaway. Torque 3/4" locknuts to 180-190 ft lbs.

Set the completed Inner Arm Assembly aside until called for later in instructions.

Step 3 Assemble one Outer Arm Assembly by installing extension tube (6) inside the end of each outer arm weldment (5). Leaving 5 holes exposed in the extension tube (beyond the outer arm) for 15 ft drill with 7.5" row spacing, secure the extension by installing (2) 1/2 x 3.5 long Grade 5 HHCS (46) and 1/2" Grade 8 flange locknuts (48); torque to 70 ft lbs. Install 3/4" x 2" long HHCS (64) and 3/4" jam nut (65) into weld nut near end of outer arm weldment. Tighten 3/4" HHCS against extension tube to remove all play (approx 50 ft lbs) secure jam nut to prevent loosening. See figure 2.

Step 4 Marker Hub End Assembly item (9) is shipped partially assembled. Some of the following steps are for reference or service only. See figure 3. Assemble one Marker Hub End Assembly (9) by:

Check shaft end and seal area of (10) are free of paint. Press seal (11) onto end of shaft. Side of seal marked "bearing side" to be flush with shoulder of shaft. Pre-fill bearing cones (12) with lithium based grease, coat OD of seal (11) with grease, grease must penetrate between seal lips.

Tap one bearing cone (12) onto shaft end of (10) with small end out. Slide hub assembly (13) (which includes outer races and seal ring and studs) onto shaft, seal and bearing. Check seal is riding on nylon ring in hub. Add additional grease around shaft to fill gap between bearings. Slide second bearing cone (12) onto shaft, small end in. Mount tongue washer (17) and castle nut (19) on shaft.

While turning hub, tighten nut (19) until hub cannot be turned by hand. Back off nut and retighten finger tight only. Back nut off 2 flats, insert cotter pin (18), bend long end of pin only up 180 degrees against end of shaft.

Tap grease cap (20) on end of hub using capped 2" std pipe nipple as a tool. Do not strike cap (20) directly with a hammer. Check hub turns freely on shaft & cotter does not rub on inside of cap.

Note: The Dawn Marker system is designed to always operate with the concave side of the disc toward the center of the drill.

Mount notched disc (21) over studs or bolts on hub with concave side of disc toward guard (10) and slotted end of marker end assembly. Assemble depth band (22) and triangular retainer (23) over studs or bolts as shown. Torque (3) 7/16 UNF locknuts to 40-45 ft lbs. Set Hub End Assembly aside until called for later in instructions.

IMPORTANT: Do not mount Hub End Assembly to marker arm until after all other assembly is complete and the marker has been hydraulically sequenced sufficiently to remove air from the system as described later in these instructions.

Step 5 Assemble hydraulic sequence valve (39) to valve mounting bracket (38) using 3/8 x 1.25 Grade 5 HHCS and 3/8" lockwashers, torque to 25 ft lbs. Attach mounting bracket (38) to fore/aft frame tube with U bolts as shown in figure 4. Dimension * = approx. 18". Take care to protect valve and cylinder ports, fittings and hose ends from contamination by dirt during assembly. Do not remove protective caps until a connection is made. Dawn makes every effort to deliver clean hydraulic components.

Warranty claims resulting from contaminated hydraulic systems are beyond the control of the Dawn Equipment Company. Claims determined to be due to contamination will not be allowed.

Step 6 Mark Drill Frame and Attach Mount. Make a vertical pencil mark in the drill front frame tube 29.0" in from both ends of the drill frame (dimension ** in figure 4 = 29"). Assemble mounts (24) & (25) to drill frame, aligning edge of mount with pencil mark at ** (see figure 4). Use U-bolts and hardware as shown. Note: Outer mount U-bolt leg must be no more than 5.25" long (inside dimension) to clear inner arm in operation. Do not substitute U-Bolts. Tighten U-bolts evenly to approx 75 ft lbs.

Step 7 Install Marker Lockup Pins in STORAGE position on mounts (24) and (25) by inserting longer end of bright red pin (72) downward through lower receptacle on inner surface of mount as shown in figure 4. Retain pin (72) in mount (24) & (25) by inserting retainer pin (71) through hole in (72) below storage receptacle. Lockup pins are temporarily installed in storage position until arms are raised using an hydraulic power source in a later step.

IMPORTANT: MARKER LOCKUP PINS SHOULD NOT BE IN THE UPPER "LOCKING" RECEPTACLE WHEN MARKER ARMS ARE DOWN OR IN USE. LOCKUP PINS SHOULD BE IN THE LOWER "STORAGE" POSITION EXCEPT WHEN MARKERS ARE LOCKED IN PLACE FOR TRANSPORT OR STORAGE.

Step 8 Attach Inner Arm Assembly (1) , as shown in figure 1, and spring attachment point to Mount Weldment (24 & 25) by inserting 8" long pin (26) as shown in figure 4 with grease zerk to rear. Tap shaft in place with soft

hammer to avoid damage to shaft. Align retaining holes in pin and mount. Install retaining screw (62) and nut (63) through mount boss and pin as shown. Check correct pin (approx 8" long) has been used and there is full engagement in mount. Select Inner Arm Ass'y (1) such that "Dawn HD Marker" decal reads correctly (left to right) when viewed from the tractor cab.

Attach machined link (69), bushing (57), retaining washer (58), lockwasher (59) and nut (60) to mount weldment as shown in figure 4. Torque 5/8" nut (60) to 140-150 ft lbs.

Step 9 Supporting inner arm assembly approximately level on sturdy sawhorse or bench, attach Load Bar Assembly (33) to existing holes in end of drill using screws (55) washers (47) and nuts (48). Horizontal legs of angles on (36) and (37) should sit on frame tube and extend toward centerline of drill as shown in figure 4. Slide Load Bar Assembly (33) forward into light contact with Inner Arm Assembly (1). Inner arm (1) must be free to move vertically. Tighten Load Bar Mounting bolts to 90 ft lbs.

Step 10 Attach Outer Arm Assembly (with extension) to end of Inner Arm (1) by inserting pin (8) (approx 5.75" long) as shown in figure 2, through boss in outer arm and through boss below outer end of inner arm (1). Insert pin with grease zerk to rear. Tap shaft in place with soft hammer to avoid damage to shaft. Align retaining holes in outer arm boss and pin, install retaining bolt (62) through outer arm boss and pin. Retain with nut (63) as shown, torque (62) to approx 25 ft lbs. Check there is full engagement in mount and zerk is to the rear.

Caution - joint between inner and outer arms is a pinch point.

Attach cable attachment arm (7) (see figure 2) to front surface of the outer arm (5) using screw (56), bushing (57), 1.75" od washer (58), lockwasher (59) & nut (60). Torque nut (60) to 140-150 ft-lbs.

Step 11 Attach Cable Assembly With marker inner and outer arms attached to mount and drill frame and supported in approximately horizontal position (support under outer arm (5)), attach spring (27) and cable assembly (28) between mount and outer arm by attaching one end of spring (27) machined link (70) bolted to mount.

Screw jam nut (60) and adjustable clevis (30) approx 1" onto threaded end of cable assembly (29). Attach swivel end of cable assembly (29) to hole in cable attachment arm (7) using clevis pin (31) and cotter (32).

Adjust cable length so that spring is extended approx 1/4" from solid length when outer arm extension end is approx 6" above floor (ground level). Tighten cable adjustment jam nut. Cable length will be rechecked in a later step.

Arm assembly should remain in extended position supported by blocks under the outer arm (5) for following steps until instructed to raise using an hydraulic power supply.

Step 12 Attach Hydraulic Cylinder (40) between mount (24) and inner arm slide plate (4). Note slide plate must be on centerline of inner arm. Cylinder ports should face forward as shown in figure 5. Insert two cylinder pins and retain with four cotters provided. Bend cotters approx 180 degrees to avoid snagging residue and eliminate sharp point.

Install hydraulic fittings (43) in cylinder ports at 45 degrees as shown in figure 5.

Step 13 Install 90 degree bent tube end of Hose Assemblies to 2 fittings on rear of valve (39) identified on valve decal as "Left Hand Cylinder" with hoses oriented approximately vertical as shown in figure 5. Note instructions on valve top decal. Tighten nuts on 90 degree hose ends on valve. Install one sleeve (42) over 2 Left Hand cylinder hoses.

Secure two LH hoses together with one tie strap (44) approx 12 inches above valve (39). Secure LH hose and sleeve bundle loosely with tie strap (44) through existing unused hole in Drill LH frame member flange as shown in fig 5. Route hose bundle around front side of mount (24) insuring hose bundle is not able to be pinched between inner arm and mount when arm is later raised.

Attach straight swivel nut on end of each LH hose to fitting on correct port on cylinder (40) as identified by decal on top of valve (39). See also figure 6.

To avoid twisting hose and shortening hose life, straight swivel nuts on hoses (41) should be tightened to cylinder fittings (43) only after nuts on 90 degree ends are tightened and hoses are properly routed to correct ports on cylinder (40).

IMPORTANT: Trace each hose by hand from valve port to cylinder port to assure hose goes to correct port on cylinder. Connecting cylinder and valve ports incorrectly may cause erratic and unpredictable operation of the marker arms. Please recheck hoses are connected to proper ports on valve (39) and cylinders (40). Proper ports are identified on decal on valve (39) and figure 6.

Repeat steps 2 through 13 for RH side as required. Grease four zerk fittings on the rear of shafts (8) and (26) until grease is visible between shaft and arms. Use a lithium-based grease.

Step 14 Connection to tractor. The Dawn HD Marker system is designed to operate from a tractor valve independent of the drill. [Deere recommends the markers be operated independently of the drill to avoid possible interaction with the drill hydraulic system]. Hoses between tractor and marker sequence valve are not supplied with marker.

Back tractor, which will be used with drill, up to drill and connect hitch per drill manufacturer's instructions. Determine hose length required between desired tractor valve and Dawn marker sequence valve (39). Allow for hose routing through loop on hitch and tractor turns. Dawn suggests using SAE 100R2 or better hose with 9/16-18 JIC 37 degree straight swivel nut on end to be attached to sequence valve (39). Clean hoses and fittings by blowing with compressed air to avoid contamination. Cap hose ends when not in use.

Attach two hoses between tractor valve and appropriate port on front surface of sequence valve (39). See decal on valve (39) and figure 6 for marker raise and lower port identification. It is suggested that valve handle forward be used for marker lower function and valve handle back be used for marker raise function.

Step 15 Initial Marker operation. Check areas on both sides of drill are clear during following steps. Marker Lockup pins should be in the lower (storage) receptacles on mounts (24) & (25). Both LH and RH marker assemblies.

Marker arms at this point should be extended on both sides of drill and suspended by marker cable assembly (28). Do not attach marker hub end assemblies with discs to arms until instructed.

With tractor at or near low engine idle speed, carefully operate marker control in tractor in the raise direction to supply hydraulic oil to marker hoses, valve and cylinders. Check tractor hydraulic oil supply has sufficient oil to fill marker system.

Caution - either or both arms may come up unexpectedly as cylinders fill with oil. Dawn suggest stationing a second person on ground to keep passersby out of marker cycling areas on both sides of drill while operator is in tractor cab.

Operate tractor valve to cycle both arms up & down until air is worked out of system and arms operate smoothly and alternately each time tractor valve lever is cycled. If operation is inconsistent or incorrect, shutoff tractor engine with both arms in the extended (down) position only. Re-trace hose connections are to the correct ports on Sequence valve (39) and Cylinders (40). Caution - if hose connections are loosened with markers raised they may fall unexpectedly.

Step 16 Set Marker Raise and Lower Speed - After marker arms (less hub end assemblies) have been cycled sufficiently to operate smoothly and alternately at engine low idle, gradually increase tractor engine speed to high idle.

Set Speed control adjustment screw on Left Hand side of valve (39) to obtain a speed of 4 seconds to fully raise an extended marker arm with tractor engine at high idle speed. Note this screw controls the "Raise" speed of both

marker arms. Similarly, set the speed control adjustment screw on the Right Hand side of valve (39) to obtain a speed of 4 seconds to fully lower a raised marker arm with tractor engine at high idle speed. Lock speed adjustment screws by tightening jam nuts. Recheck speed is no faster than 4 seconds to raise and 4 seconds to lower. **Note:** if you are unable to slow the speed of the marker arms to 4 seconds to raise and 4 seconds to lower, it may be necessary to adjust the "turtle/rabbit" speed control on most tractor valves in addition to the speed control on the Dawn marker valve (39). See your tractor operator's manual for information.

Step 17 Mounting Hub End Assemblies, Rechecking Width - With marker arms in extended position and after obtaining correct hydraulic operation and speed, turn tractor engine off. Attach Marker hub end assemblies (assembled in step 4 above) to outer 2 holes on extension tube (6) using bolts (55), Washers (47) and Locknuts (48). See figure 2. Hub End Assembly should be on bottom of extension tube (6). Adjust angle from straight to 15 degrees rearward to change aggressiveness of marker to suit conditions. Tighten nuts (48) to approx 90 ft-lbs.

With tape measure, check width of mark by measuring nominal drill width (i.e. 15 ft) from centerline of drill on both sides. Adjust marker arm extensions in or out as required in 2.75" increments. See step 3 above. Readjust load bars (33) and (34) to contact inner arm (1) when arm is in operating position. Torque load bar mounting bolts (55) to 90 ft-lbs.

Step 18 Install Lockup Pins - Again clear area on both sides of drill. Start tractor engine and hydraulically fully raise either right or left marker. Install marker lockup pin by removing retainer (71) and moving lockup pin (72) from lower storage position (see fig 4). Install locking pin (72) through latch plate on inner arm (2) and through upper receptacle on mount (24) or (25). Retain lockup pin in upper position by reinstalling retainer (71).

Slight adjustments may be made in upward limit of arm travel by adjusting rod end clevis of cylinder (40). **Note:** Rod end must be fully engaged in clevis - do not adjust rod end clevis more than 1/8". Loosen clamp bolt and turn rod by grasping in painted area only - do not mar polished cylinder rod finish. Retighten Rod end clevis clamp bolt. Repeat Lockup pin installation for opposite side.

Step 19 Recheck Cable Length Adjustment - With marker arms pinned in raised position and marker hub end assemblies attached, readjust length of cable assembly (28) at clevis (30) to obtain 1/2" clearance between outer arm stop and inner arm (3), lock clevis (30) with jam nut. Repeat cable length readjustment for opposite side.

Caution - during cable length adjustment beware of sharp edge of notched disc.

With proper cable length adjustment, on level ground marker arm will extend essentially full length before disc strikes ground. Marker in raised position remains within transport width of drill and below cab height of most tractors. Marker installation is now complete.

DAWN Heavy Duty Marker Operations

A.) Marker lockup pins should be installed in lockup position whenever transporting or storing drill. During field operation store lockup pins in lower storage receptacles.

B.) Markers operate independently of drill. Be sure areas on both sides of drill are clear before operating markers. The sequence valve operates in the conventional manner:

-Activating tractor valve lowers one marker arm
 -Opposite movement of tractor valve raises the marker arm
 -Activating tractor valve again lowers the opposite marker arm
 -Opposite movement of tractor valve raises that marker arm
- and so on.

If it is desired to raise and lower the same arm twice in succession, often a short, quick movement of tractor valve lever will cycle the sequence valve without fully lowering opposite marker arm. Caution - make sure both sides of drill are clear before attempting this short intermediate lever movement.

C.) Breakaway protection. If you desire breakaway protection, remove the FRONT pivot bolt (49) from each inner arm (1), leaving the REAR pivot bolt (49) in place as assembled in step 2 above.

If Breakaway protection is not desired, both pivot bolts (49) may be left in each arm to prevent unnecessary breakaway activation. Note there is no breakaway protection if both pivot bolts (49) are left in one marker arm.

The Dawn HD Marker breakaway protection system includes a built in stop to prevent the marker arm from pivoting into contact with drill after breakaway activation.

If breakaway should activate:

-stop forward travel immediately
-leave activated arm in the down position
-shut off tractor engine
-brush or blow any dirt or foreign matter from area of breakaway pivot, do not use finger-this is a pinch point
-standing outside hub end depthband, grasp guard loop of hub support weldment (10) and roll the

notched disc forward in an arc until marker is extended straight out.

.....Replace two Breakaway bolts (46), washers (47) and nuts (48) with identical grade and size hardware.

See Step 2 above. Torque to 90-100 ft. lbs. Use proper screws flat washers and nuts.

DAWN Heavy Duty Marker Maintenance

Daily:

- Grease four Zerk fittings on the rear of pivot pins (8) and (26)
- Visually inspect that the marker lockup pins and retainers are in place and in good condition.
- Visually inspect breakaway bolts. Are there spare 1/2-13 x 3-1/2" long SAE Grade 5 HHCS, 1/2 SAE Flatwashers and 1/2"-13 flange nuts available for quick replacement during planting season?
- Perform a "walk-around" visual inspection of marker cable assemblies, nuts, bolts, pins, load bars, hoses, hose routing and tie-downs, cylinders and decals. Replace any missing or damaged parts.

Annually:

- Regrease hubs. Thoroughly pressure wash marker, especially hub end assemblies. With marker arms extended and blocked under outer arm, remove retainer, depth band and notched disc. Remove grease cap, inspect bearings for looseness, water or dirt. If OK, fill grease cap approx 1/2 full with clean lithium grease and replace cap, etc as detailed in step 4 above. Use capped pipe nipple as a tool to replace grease cap. Do not strike grease cap directly with a hammer.
- Replace breakaway bolts. Replace four 1/2-13 x 3-1/2 long SAE grade 5 breakaway bolts. see step 2 above.
- Adjust Load Bars (33) & (34) to keep in contacted with Inner Arm (1) in operating position.
- Inspect all moving parts and cable assembly. Adjust or replace as required. Replace any damaged or missing decals.

MARKER SADDLE, CABLE ASSY, LOAD BAR & VALVE MOUNT

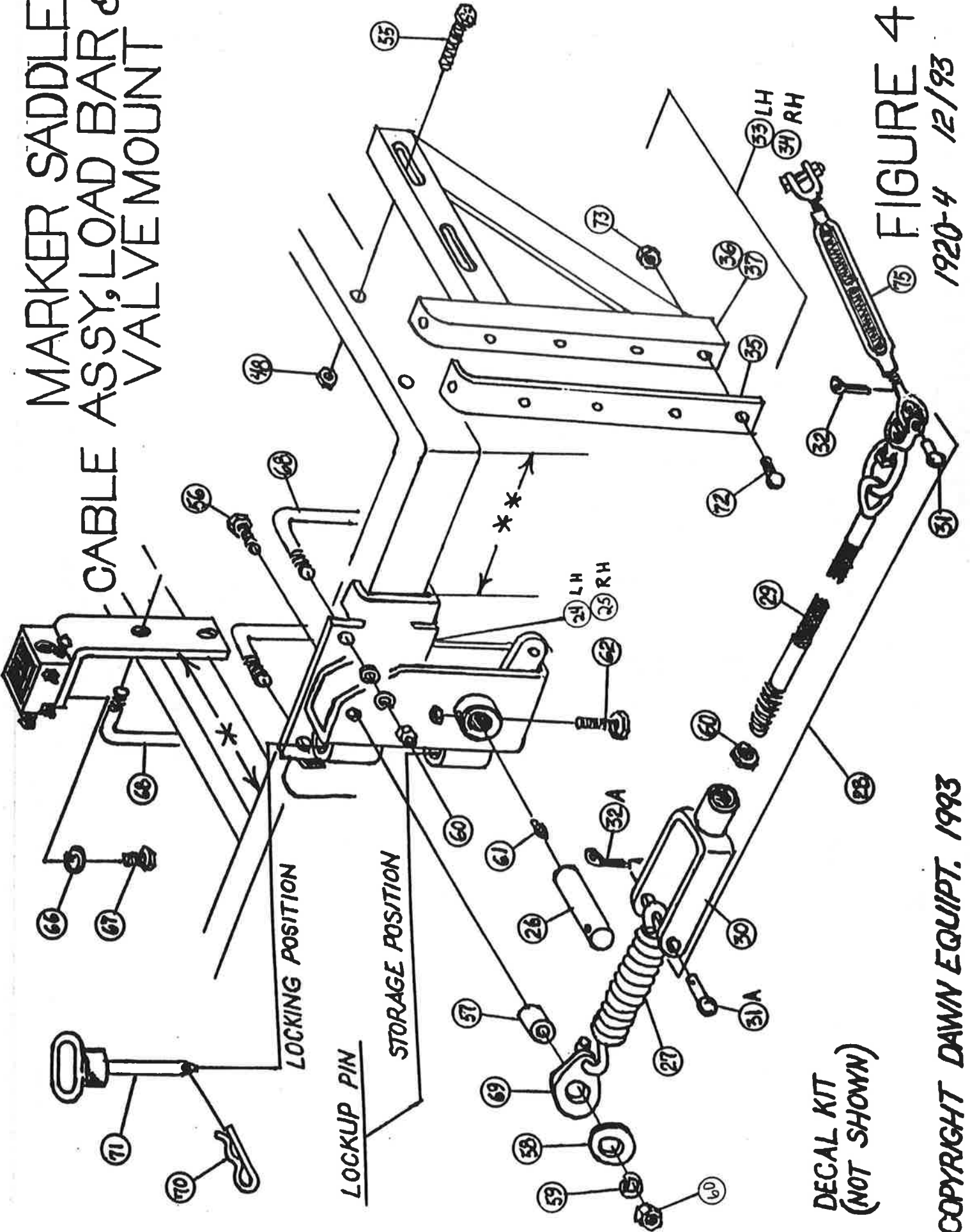

DECAL KIT
(NOT SHOWN)

FIGURE 4
1920-4 12/93

MARKER HUBBEND ASSY.

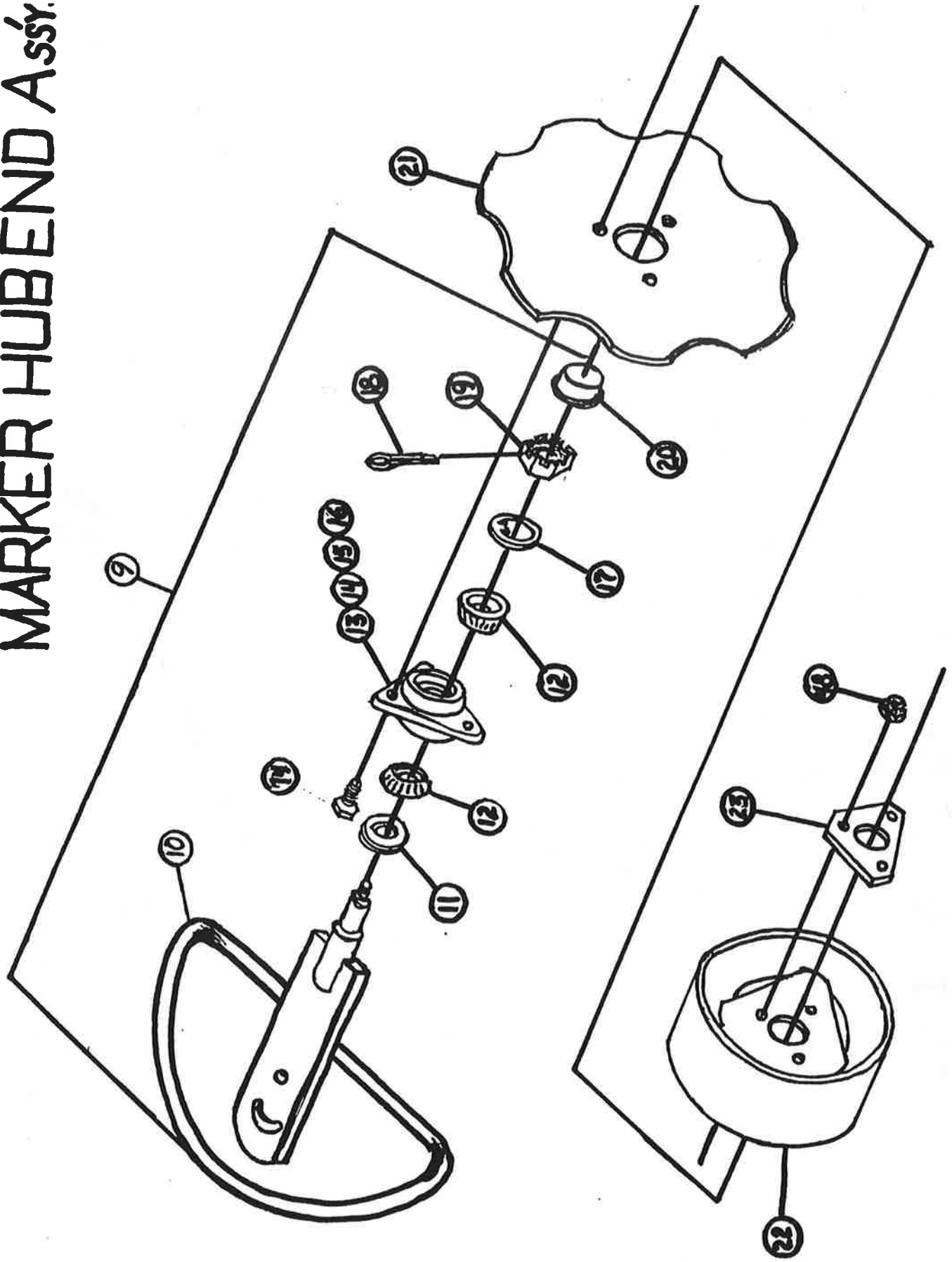

FIGURE 3

COPYRIGHT DAWN EQUIPT. '93

1915-3 12/93

MARKER OUTER ARM ASS'Y

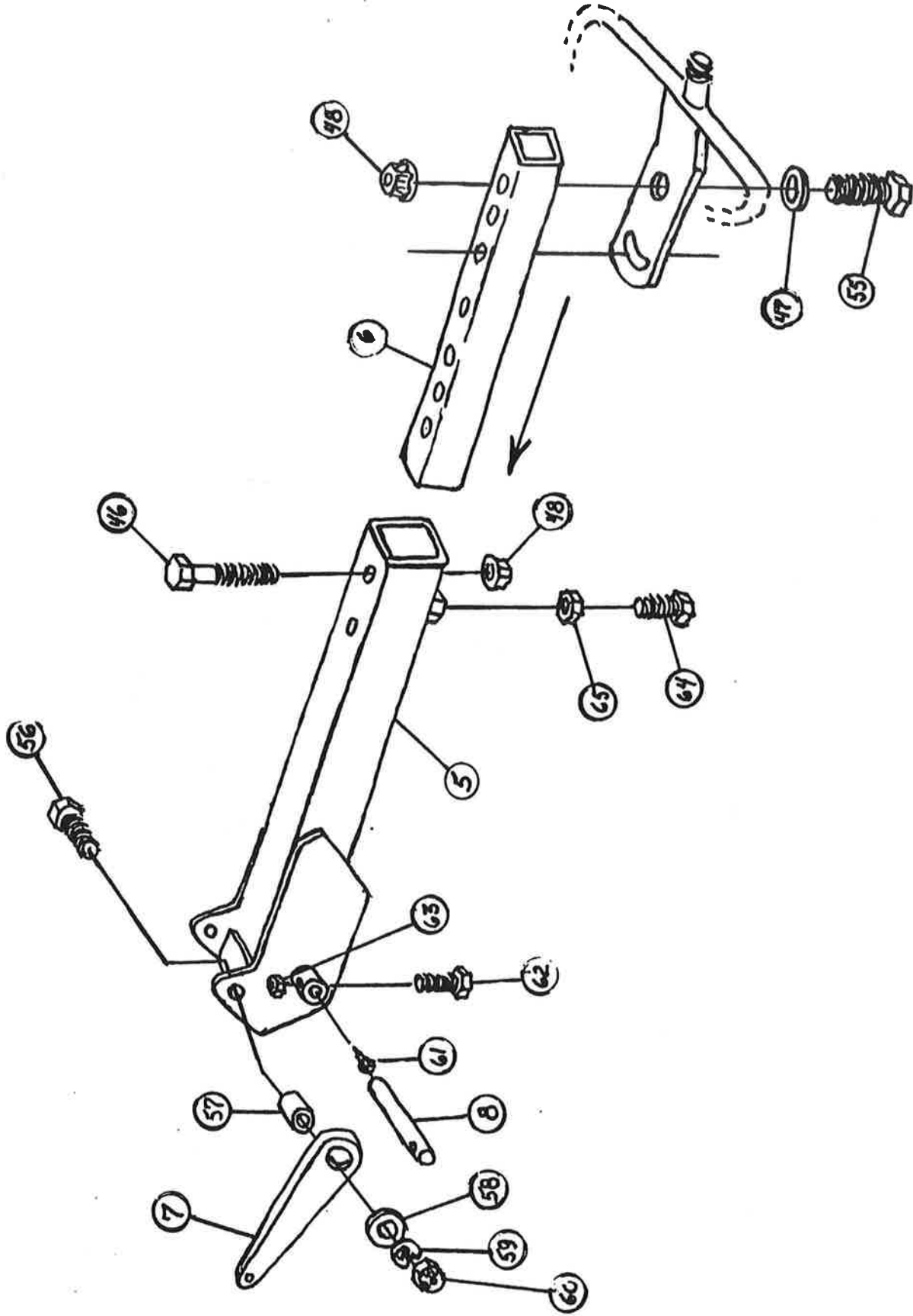

FIGURE 2

MARKER INNER ARM w/ BREAK AWAY

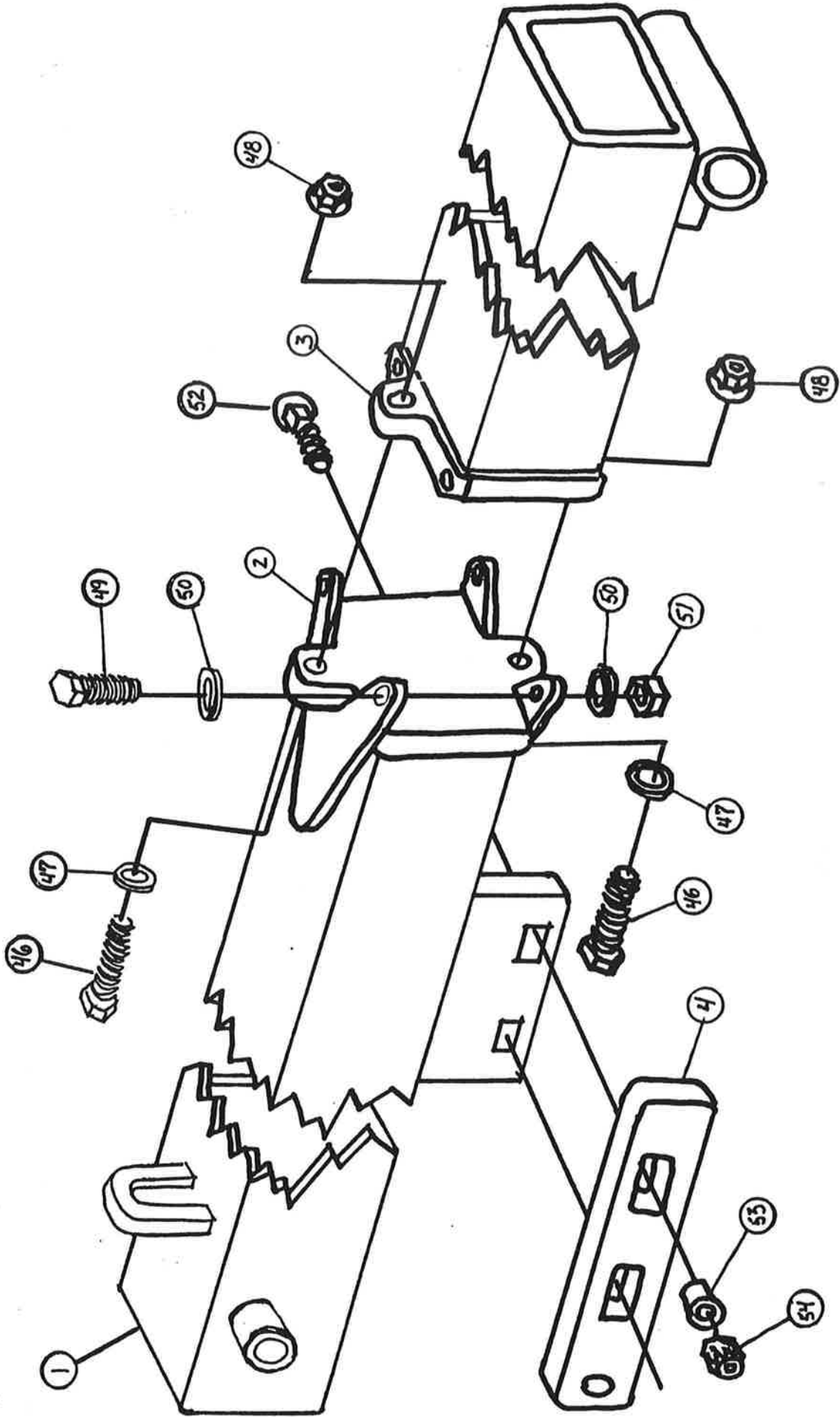

FIGURE 1

MARKER HYDRAULICS

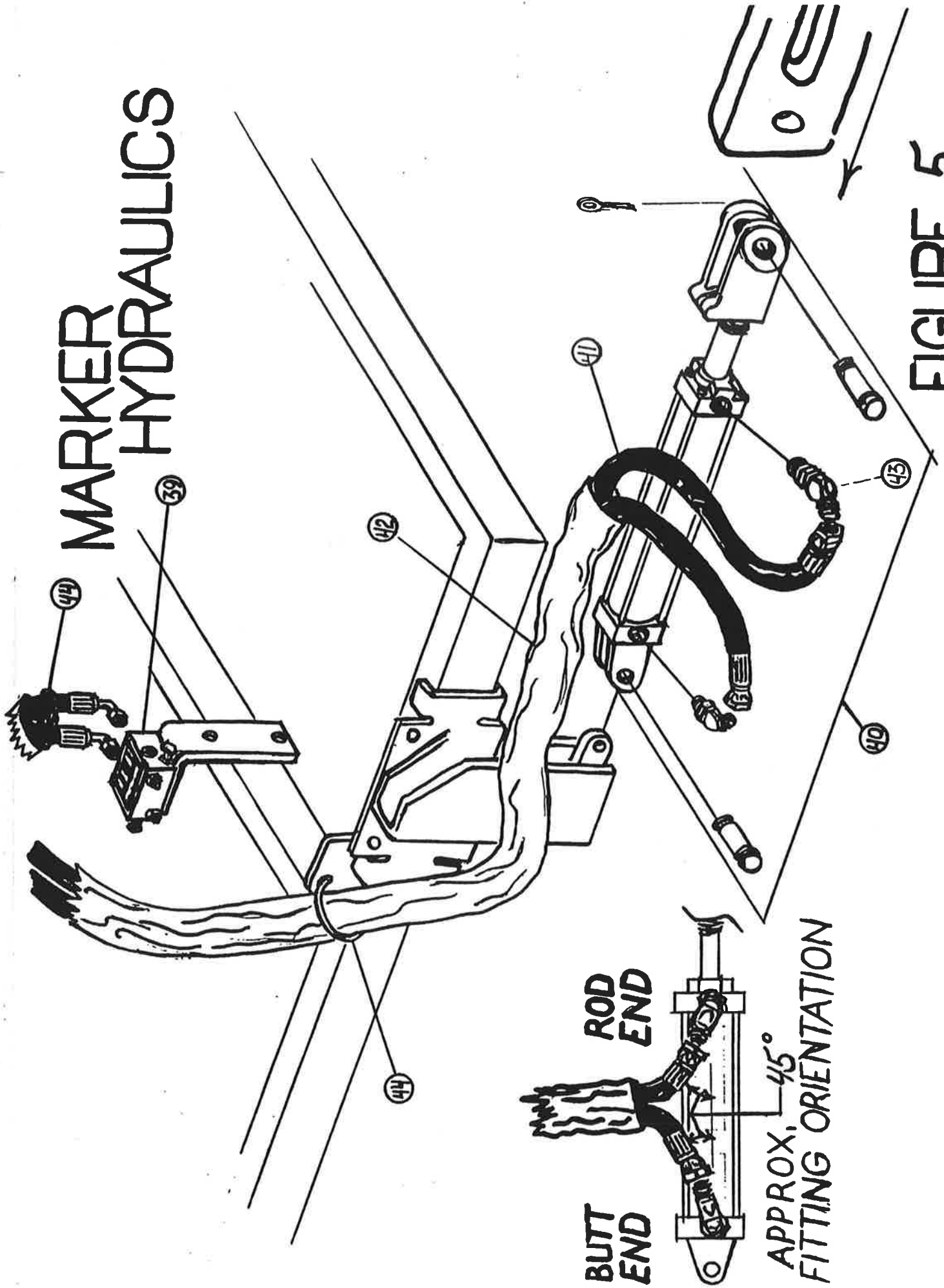

FIGURE 5
1915-5 12/93

DAWN® Heavy Duty Marker System - 20' COMPONENT LIST

ITEM #	PART #	DESCRIPTION	REQ'D #
1	200-091	Inner Arm Ass'y 15' w/Breakaway (includes #2 & #3)	2
2	-	Breakaway, Inner (not sold seperately)	-
3	-	Breakaway, Outer (not sold seperately)	-
4	100-146	Bar/Slide	2
5	200-086	Outer Arm Weldment - Adjustable 15'	2
6	200-085	Extension Tube Weldment	2
7	100-149	Arm, Cable Attachment	2
8	100-154	Pin, Outer 5.75" Long	2
9	400-015	Marker Hub End Ass'y (includes #10 thru #20)	2
10	200-068	Hub Support Weldment	-
11	9017	Seal, Triple Lip	-
12	9016	Cone Bearing	-
13	300-041	Hub, Press Ass'y (includes #14 thru #16)	-
14	200-075	Hub, Machined	-
15	9015	Cup, Bearing	-
16	9018	Ring, Seal	-
17	9028	Washer, Tongue	-
18	9019	Pin, Cotter	-
19	9024	Nut, Slotted	-
20	9027	Cap, Grease	-
21	9116	Disc, Notched 18"	2
22	200-067	Depth Band Weldment	2
23	100-079	Retainer, Grease Cap	2
24	200-073	Marker Mount Weldment, Left Hand	1
25	200-072	Marker Mount Weldment, Right Hand (not shown)	1
26	100-166	Pin, Inner 8" long	2
27	100-337	Spring, Extension	2
28	100-143	Cable Ass'y 15' (includes #29 thru #31A)	2
29	-	Cable w/Swivel	-
30	-	Clevis, Adjustable	-
31	-	Pin, Clevis	-
31A	-	Pin, Clevis	-

DAWN® Heavy Duty Marker System - 20' HARDWARE LIST (Continued)

ITEM #	PART #	DESCRIPTION	REQ'D #
62	9144	HHCS, 3/8-16 X 2.5 Grade 5	4
63	9081	Nut, Lock 3/8-16 Grade 5	4
64	9148	HHCS, 3/4-10 X 2 Grade 5	2
65	9149	Nut, HX Jam 3/4-10 Grade 5	2
66	9146	LW, 3/8	2
67	9080	HHCS, 3/8-16 X 1.25 Grade 5	2
68	100-237	U-bolt, 6 X 5.25 X 5/8	5
69	100-313	Link, Machined	2
70	9137	Pin, Hairpin	2
71	9152	Pin, Marker Lock Up	2
72	9133	CB, 5/16-18 X 1 Grade 5	-
73	9121	Nut, Lock 5/16-18 Grade 5	-
74	9079	HHCS, 1/2-13 X 1 1/2 UNC	6
75	100-261	Clevis Extension (for 20' Marker only)	2

Figure 6

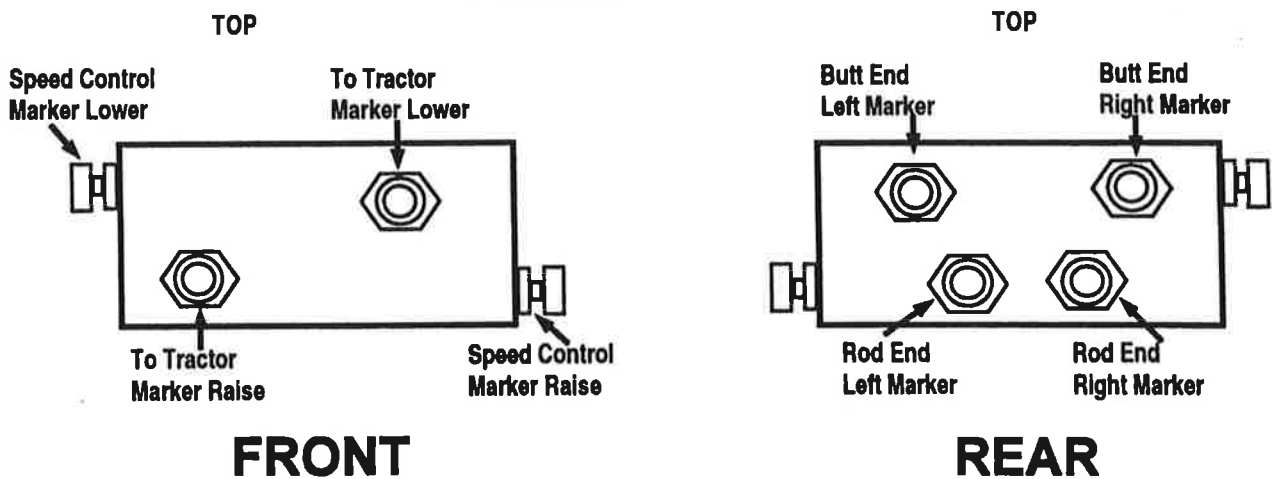

32	-	Pin, Cotter	-
32A	-	Pin, Cotter	-
33	300-040	Load Bar Ass'y, Left Hand (inc #35, 36, 73, 74)	1
34	300-039	Load Bar Ass'y, Right Hand (inc. #35, 37, 73, &74) [not shown]	1
35	100-179	Strip, Wear	-
36	200-084	Load Bar Weldment, Left Hand	-
37	200-083	Load Bar Weldment, Right Hand [not shown]	-
38	100-182	Bracket, Valve Mount	1
39	9112	Valve, Sequence	1
40	9171	Cylinder, Hydraulic 2 1/2" X 8" (inc.cotters)	2
41	9279	Hose Ass'y	4
42	9127	Sleeve, Hose Protector (fits around pair of hoses)	2
43	9134	Elbow, Hydraulic (135 degree)	4
44	9151	Tie Strap, Heavy Duty Nylon	3
45	300-045	Decal Kit - Marker (includes all decals) [service only]	-

DAWN® Heavy Duty Marker System - 20' HARDWARE LIST

ITEM #	PART #	DESCRIPTION	REQ'D #
46	9138	HHCS 1/2-13 X 3.5 Grade 5	8
47	9003	FW, 1/2 X 1.06 OD	8
48	9007	Nut, HX FLG Lock 1/2-13 Grade 8	12
49	9145	HHCS, 5/8-11 X 5 Grade 8	4
50	9032	FW, 5/8 SAE Hard	18
51	9142	Nut, HX Lock 5/8 All-Metal Grade 8	4
52	9128	CB, 3/4-10 X 2.75 Grade 5	4
53	100-170	Step Bushing	4
54	9129	Nut, HX Lock 3/4-10 Grade 5	4
55	9140	HHCS, 1/2-13 X 4 Grade 5	8
56	9102	HHCS, 5/8-11 X 2 Grade 8	4
57	100-183	Bushing, 9/16 Long	4
58	9141	FW, 5/8 X 1.75 OD	4
59	9069	LW, 5/8	12
60	9126	Nut, HX 5/8-11 Grade 5	12
61	9114	Fitting, Grease 1/4-28 Straight	4

Heavy Duty Marker Limited Warranty Agreement

The following warranties with respect to new DAWN Equipment Company products, excepting as hereafter provided, is made by DAWN to Dealers ("Dealers") authorized by DAWN to sell the products involved and each selling Dealer, in turn, make such warranties to the original retail purchaser (the "purchaser").

A. Duration and Extent of Warranty

1. Products, except as hereafter provided, which are defective in materials or workmanship as delivered to the Purchaser by a Dealer will be repaired by a Dealer or replaced by DAWN, only, as DAWN elects, without charge for materials or labor, if such defect appears in not more than 12 months, or from and after the date of delivery to the Purchaser by the Dealer.
2. Liability of DAWN for defective parts or materials is specifically limited to the value of the parts or materials, only.
3. All parts or materials requiring warranty work MUST be returned by delivery to the selling Dealer for repair or for delivery to DAWN within thirty(30) days of occurrence of the defect or failure of the part or material, all freight prepaid by the Dealer. Upon completion of the warranty work, DAWN will ship parts or material to Dealer, freight prepaid by DAWN.
4. Hydraulic cylinders, valves and hoses are warranted by their manufacturers through DAWN Equipment Co.. All decisions on the product involved will be made by its manufacturer and are final.
5. All decisions by DAWN pertaining to warranty work are final.

B. Warranty Exclusions

DAWN will not be responsible for any of the following:

1. Defects or damage resulting from use, repairs or service performed in a manner not approved by DAWN or from repairs or service performed by someone other than an authorized DAWN Dealer service department, (after approval from DAWN), or DAWN.
2. Defects, damage or failure resulting from any alteration or additions done in a manner not approved by DAWN.
3. Defects, damage or failure or depreciation resulting from wear and tear, accident, misuse, negligence, improper maintenance or improper protection and storage.
4. INCIDENTAL OR CONSEQUENTIAL DAMAGES, INCLUDING BUT NOT LIMITED TO, LOSS OF PROFITS, LOSS OF TIME, LOSS OF CROPS, INCONVENIENCE, LOSS OF USE OF THE PRODUCT OR OTHER MACHINERY, EQUIPMENT OR VEHICLES USED WITH THE PRODUCTS, COST OF RENTALS OR REPLACEMENT OF THE PRODUCTS OR OTHER COMMERCIAL LOSS.

C. Remedies Exclusive: No Other Warranties

The obligations of DAWN and the Dealers are limited to the obligations set forth in this Limited Warranty. THIS LIMITED WARRANTY IS IN LIEU OF ALL OTHER WARRANTIES OF DAWN, AND THE DEALERS, EXPRESSED OR IMPLIED. WARRANTIES BY DAWN OR THE DEALERS OF CONDITION QUALITY, MERCHANTABILITY OR FITNESS FOR A PARTICULAR PURPOSE ARE EXCLUDED, AS ARE ALL OTHER REPRESENTATIONS BY DAWN AND THE DEALERS TO THE PURCHASER OR USER AND ALL OTHER OBLIGATIONS OR LIABILITIES OF DAWN AND THE DEALERS. NO OTHER PERSON IS AUTHORIZED TO GIVE ANY OTHER WARRANTY OR TO ASSUME ANY OTHER LIABILITY ON BEHALF OF DAWN OR THE DEALERS. THIS LIMITED WARRANTY MAY NOT BE TRANSFERRED BY THE PURCHASER TO ANY SUBSEQUENT OWNER.

D. The instruction manual supplied with the Product contains important safety, maintenance and service information. Read the manual and follow recommendations contained therein. Please remember that failures due to improper maintenance or service are not covered by the Limited Warranty.

DAWN Equipment Company reserves the right to make changes in design or specifications at any time without obligation to purchasers or equipment and components previously sold. This warranty shall not be altered or changed in any way.

DAWN EQUIPMENT COMPANY
P.O. Box 497, 370 NORTH CROSS, Sycamore, IL 60178

©DAWN Eq. Co. US Pats #4,785,890; 5,129,282; Other US & Foreign Patents Pending. The Dawn HD Marker System is also covered by US patent pending. DAWN and HD, (Heavy Duty), are trademarks of the Dawn Equipment Company. JOHN DEERE and 750 Drill are trademarks of Deere & Company. DAWN HD Marker Instructions Dawn P/N 8017 Rev 1 Copyright Dawn Equipment Company 1993.

